

TRIVERSA™

Triversa™ Installation Instructions

GENERAL INFORMATION

ATTENTION! READ BEFORE INSTALLING!

- Handle cartons and flooring carefully to protect the locking edge profile. Always transport and store cartons in the original packaging, neatly stacked horizontally on a smooth, flat, solid surface. Do not stack pallets more than 3 high and protect the package corners during storage.
- Triversa is recommended for residential and commercial use in dry, interior, heated areas.
- Under typical conditions, Triversa does not need to be acclimated to the jobsite. Acclimation is recommended if extreme temperature variations occur during storage or transportation. For best results, acclimate the **room(s)** at a constant temperature between 65°F and 85°F for 48 hours prior to, during and after installation. Temperature thereafter should be maintained between 50° F and 100° F. Do not install flooring over sloped floors, ramps or in wet areas.
- Carefully inspect flooring material prior to installation.
- Mix planks from several different cartons to ensure a random appearance.
- Always allow a 1/4" expansion space around the entire perimeter of the room, at all base cabinets, fixtures and pipes. Cover the exposed edges with trim or fill the gap with a high quality acrylic caulking.
- If the installation area has a width and/or length greater than 50 lineal feet, an expansion joint will be required. Cover the expansion joint with a Congoleum Transition molding.
- All base cabinets must be installed prior to installing flooring. Do not install base cabinets or island cabinets on top of the floor.

PREPARING THE AREA

- Remove all furniture and appliances from the room(s)
- Remove the wall base and doorway trim
- Always undercut wood door casings
- Thoroughly sweep the subfloor removing all dust and debris

SUBFLOOR RECOMMENDATIONS

Triversa can be installed over a variety of subfloor surfaces including concrete on all grade levels, wood subfloors and many existing hard surface floors. The subfloors must be clean, smooth, flat, solid and dry. Do not install planks over floors that are sloped for drainage or uneven floors where deviations are greater than 3/16" in 10' or 1/16" in 1'. Subfloor deflection should not exceed 1/360th of the span. Uneven or wavy floors must be leveled with portland cement based patching compound.

WOOD SUBFLOORS

Triversa is suitable for installation over:

- Double layer wood construction over joists or trusses on up to 19.2" on center
- Single layer APA rated Sturd-I-Floor T&G Panels, minimum 23/32" over joists or trusses up to 19.2" on center
- APA underlayment grade plywood
- Oriented strand board (OSB)
- NPA rated particleboard

Set fasteners 1/32" below the subfloor surface, sand joints smooth and fill holes and gaps wider than 1/8" wide. Install suitable underlayment when necessary to achieve a flat or solid surface.

CONCRETE SUBFLOORS

Triversa can be installed over concrete on all grade levels. Moisture vapor emissions should not exceed 5 lbs./24 hour per

1,000 sq. when tested with the Anhydrous Calcium Chloride Test in accordance with ASTM F 1869 or 80% RH in accordance with ASTM F 2170 "Standard Test Method for Determining Relative Humidity in Concrete Slabs using in situ Probes".

Fill cracks, saw cuts, and control joints that are wider than 1/8". Level wavy floors or uneven areas that exceed 3/16" in 10' or 1/16" in 1'. Do not install flooring over expansion joints.

Please note: Triversa is waterproof, but it's not a moisture barrier. Moisture won't damage Triversa, but it can penetrate the walls and affect the structure of the home. That's why it's important to make sure concrete is cured and tested for moisture.

RADIANT HEATED SYSTEMS

Triversa can be installed over in-floor radiant heating systems provided the subfloor surface does not exceed 85°F at any point. The initial floor temperature should not exceed 70°F for 48 hours prior to and 48 hours after installation. Thereafter the temperature should be gradually increased to the desired setting up to 85°F. Radiant heating systems that are installed on top of the subfloor surface must be covered with a minimum 3/4" concrete topping.

EXISTING FLOORING

Triversa can be installed over a variety of finished floors including single layer resilient sheet floors and tile, ceramic, marble and terrazzo. The surface must be in good condition with no indication of excessive moisture or moisture damage. Do not install flooring over heavy cushioned floors, cushioned backed floors or over tile installed over concrete below grade level. The grout joints in ceramic tile and marble must be leveled so they are flush with the tile surface. Additionally the tile may require several skim coats to achieve a flat surface.

ASBESTOS WARNING

WARNING: DO NOT SAND, DRY SWEEP, DRILL, SAW, BEAD-BLAST, OR MECHANICALLY CHIP OR PULVERIZE EXISTING RESILIENT FLOORING, BACKING, LINING FELT, ASPHALTIC "CUT BACK" ADHESIVE, OR OTHER ADHESIVE. THESE PRODUCTS MAY CONTAIN ASBESTOS FIBERS AND/OR CRYSTALLINE SILICA. AVOID CREATING DUST. INHALATION OF SUCH DUST IS A CANCER AND RESPIRATORY TRACT HAZARD.

TOOLS AND MATERIALS

- Pencil
- Chalk Line
- Hammer
- Pull Bar
- Power Circular saw or Jigsaw
- Tape Measure
- 1/4" Spacers
- Tapping Block
- Utility knife

CUTTING

Triversa can be cut using a score and snap technique (score with a sharp utility knife blade and carefully snap the plank) or a power

circular saw or jigsaw. Exercise care when using the score and snap method to avoid damaging the edge profile.

INSTALLATION

- For best appearance planks should be installed parallel to the long dimension of the room and preferably parallel to outside light sources i.e. windows and doors.
- Measure the width of the room and snap a chalk line down the center of the floor.
- Determine the width of the plank in the last row either through measurements or dry layouts. If smaller than one-half of the plank width, adjust the chalk line in either direction one-half of the plank width to avoid narrow pieces at the side walls.
- If the wall along the first row of planks is irregular, scribe the planks to fit and cut them.
- Plan the layout to avoid using small planks (less than 8") at the walls. The cut piece at the end of the row can often be used to start the next row provided it achieves a random layout. Always place the cut end against the wall and allow a 1/4" expansion space.
- Start the installation in the left hand corner of the room with the edge of the plank accurately positioned at the chalk line and with the tongue side toward the starting wall. (See figure 1.)

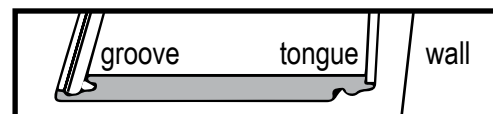

Figure 1

- Insert 1/4" spacers for expansion along the edges and ends where the planks meet the wall. (See figure 2.)

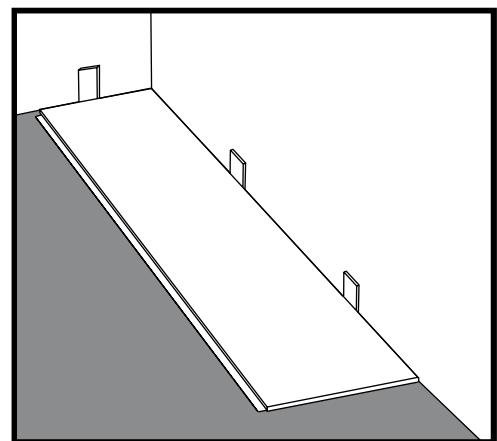

Figure 2

- Attach the second plank to the first plank in the first row by holding the plank at a low angle to the floor and inserting the end tongue into the end groove applying light pressure inward and down until the planks secure together. (See figure 3.)

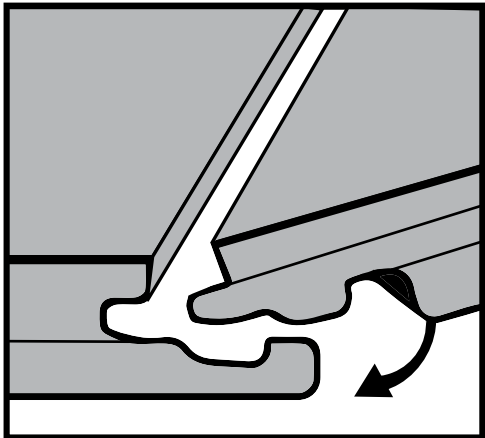

Figure 3

- Use spacers in the first row between the edge and end of the last plank and the wall to maintain a 1/4" expansion space.
- Start the second row using the piece cut from the last piece in the first row as long as it is more than 8".
- Place the cut end against the wall. Insert the tongue on the long side of the plank into the groove of the plank in the first row. Hold the plank in a low angle while applying light pressure inward and down until they secure together.
- Then, use a hammer and tapping block to secure long side of the planks together. Be sure to tap on the edge of the vinyl so as not to damage locking profile. (See figure 4.)

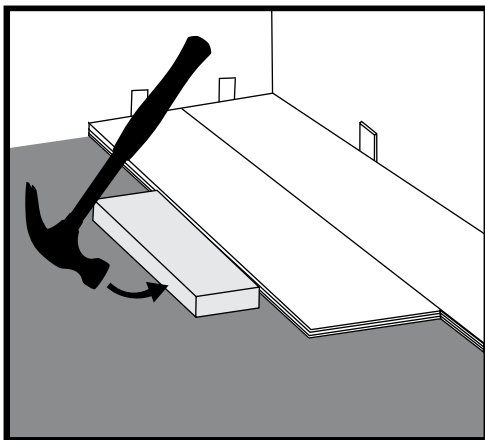

Figure 4

- Insert the tongue of the next plank into the groove of the plank in the first row. Hold the plank in a low angle while applying light pressure inward and down until they secure together.
- Slide the plank toward end of previously installed plank until the tongue just touches the groove.

- Attach a scrap piece of flooring as a guide to bridge the gap between the ends of the planks.

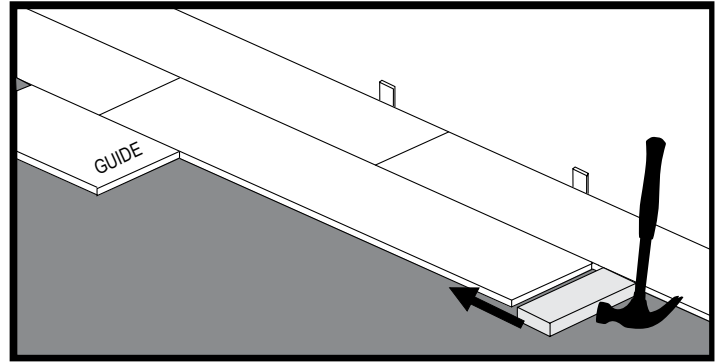

Figure 5

- Tap the end of plank using a hammer and tapping block to secure ends of planks together. (See figure 5.)
- Remove the guide and continue installing the second row in the same way.
- Use a hammer and pull bar to secure final piece in the second row allowing a 1/4" expansion space at the end of the row. (See figure 6.)

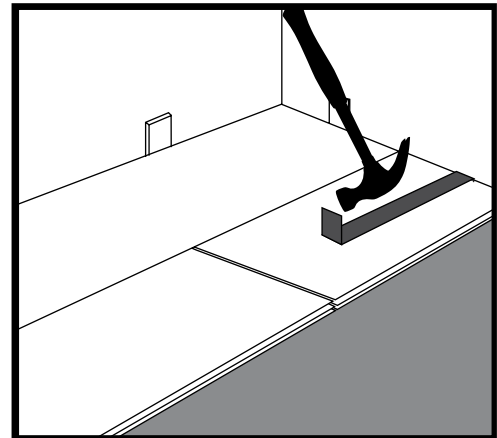

Figure 6

- Complete each row thereafter in the same manner using a random layout with end joints off-set by at least 8". Work from several different cartons to ensure a random pattern layout.
- If the wall along the last row of planks is irregular, scribe the planks to fit and cut them.
- Use a hammer and pull bar to secure long edges of planks on final row. Always use a pull bar on the cut edge of the plank. Factory edges can be damaged if the pull bar is used directly against them. (See figure 7.)

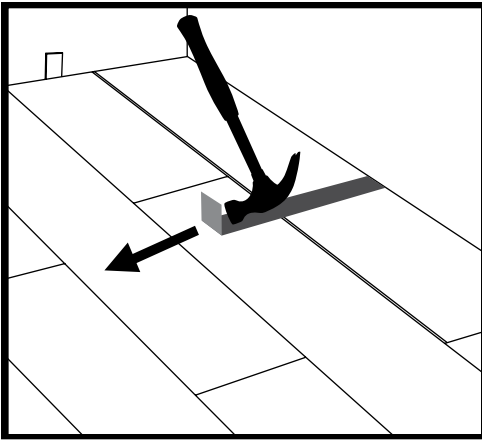

Figure 7

Triversa can be installed easily when working forward (placing the tongue in to the groove) or backward (placing the groove in to the tongue).

This allows for easy fitting around door trim and changing direction to go into alcoves or adjoining rooms.

Triversa can also be assembled by using a pull bar or tapping block in difficult areas such as the last row and when fitting around any door trim. When fitting around door trim it will be necessary to slide the plank under the trim. This can be accomplished by starting the row on the side of the room with the door trim and then sliding the plank into place once it is attached. The row can be completed by inserting the tongue in to the groove or the groove into the tongue depending on the direction.

A tapping block can also be used to secure the joints together while the planks are in a flat position. Use a piece of scrap flooring with the corresponding male or female joint and a series of light taps until the joint is gradually secured together. Do not hit the edge directly or use excessive force as it could damage the edge of the plank.

SPECIAL INSTRUCTIONS

BATHROOMS

When Triversa is installed in a bathroom the flooring can be laid under the toilet provided that the floor is separated from adjacent rooms with a doorway threshold or transition molding. Otherwise the flooring should be fit around the toilet leaving a 1/8" expansion space. Use a high quality acrylic caulking to fill the expansion space at the toilet, bathtub, shower and all wet areas to prevent surface water from seeping under the floor.

STAIRS

Triversa can be installed fully adhered over steps using AD-62 Adhesive. Follow the instruction on the adhesive for trowel size and drying time. Always use a stair nose molding to finish each step at the nose.

FULLY ADHERED INSTALLATION

In certain circumstances, Triversa can be installed fully adhered

using Congoleum AD-62 adhesive. Use a 1/16" x 1/16" x 1/16" square notch trowel. Refer to the AD-62 label for recommended substrates and open time.

FINISHING THE JOB

Remove all spacers. Install wall trim so it does not pin or restrict the floor from moving. Drive fasteners into the wall and not the floor. When installing Congoleum Transitions or doorway transition moldings allow a 1/4" expansion space between the edge of the floor and the molding fasteners. Do not drive fasteners in to the floor. Return appliances to the room by rolling or sliding over strips of hardboard to prevent damaging the floor.

IMMEDIATELY AFTER INSTALLATION

- Protect the flooring and resume normal traffic.
- Always move heavy furniture and appliance with care to avoid scratching or gouging the floor. First, lay strips of plywood or hardboard panels on the floor. Then roll, "walk" or slide these items on the strips. Do not push or pull appliances and heavy furniture without taking these precautions.
- Damp mopping your floor using Congoleum Bright 'N Easy No-Rinse Cleaner or other suitable resilient floor cleaner after installation.

REPAIRS

Triversa is a tough, durable floor; however, if a plank becomes damaged, it can be replaced.

Damaged planks along the wall can be replaced by unlocking the planks in that area and then re-installing them after the replacement plank is installed.

To replace a plank in the body of the floor:

- Use a power circular saw to make a cut down the center of the damaged plank to within 2" of the ends. (See figure 8.)

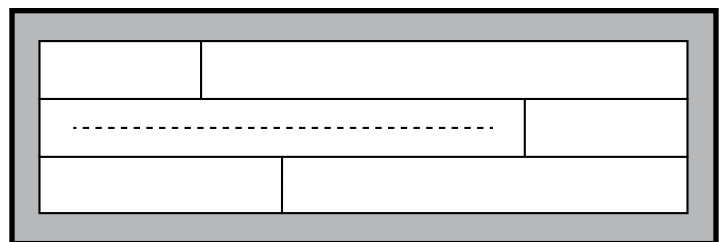

Figure 8

- Make diagonal cuts from the corner of the plank back to the center cut. (See figure 9.)

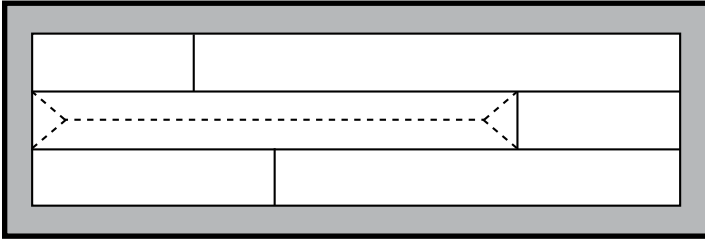

Figure 9

- Remove the damaged plank by lifting the edge of each piece until it unlocks.
- Prepare the replacement plank by removing the bottom of the groove along the long and short side. Check the replacement piece by laying it into place. The plank should fit neatly into place without gaps at the joints. Remove the plank.
- Before completing the repair, place a 2" wide strip of wax paper under the centered under the edge of the tongue on the long and short side. This will prevent adhesive from bonding the plank to the subfloor.
- Next apply a 1/8" bead of Loctite Power Grab® Heavy Duty® construction adhesive to the exposed groove along the long and short end of the surrounding planks. Do not use excess adhesive.
- Immediately while adhesive is wet install the replacement plank by inserting the tongue into the groove along the long side. Use a tapping block to secure the short end and then drop the plank into position. Remove excess adhesive from the surface and roll the edges with a steel hand roller. Clean the surface immediately with a clean cloth and mild detergent to remove any adhesive residue. Then dry with a clean soft cloth. Note: adhesive and adhesive film is not removable if allowed to dry on the surface of the floor. Apply weight to the adhered edges for 20 to 30 minutes.
- Keep traffic off the repair for 12 hours.